

# Novel Design of n-bit Controllable Inverter by Quantum-dot Cellular Automata

M. Kianpour<sup>1</sup>, R. Sabbaghi-Nadooshan<sup>2</sup>

1- Electrical Engineering Department, Islamic Azad University, Science and Research Branch, Tehran, I. R. Iran

2- Electrical Engineering Department, Islamic Azad University, Central Tehran Branch, Tehran, I. R. Iran

(\*) Corresponding author: r\_sabbaghi@iauctb.ac.ir  
(Received: 22 Jan. 2014 and accepted: 09 Feb. 2014)

## Abstract:

Application of quantum-dot is a promising technology for implementing digital systems at nano-scale. Quantum-dot Cellular Automata (QCA) is a system with low power consumption and a potentially high density and regularity. Also, QCA supports the new devices with nanotechnology architecture. This technique works based on electron interactions inside quantum-dots leading to emergence of quantum features and decreasing the problem of future integrated circuits in terms of size. In this paper, we will successfully design, implement and simulate a new 2-input and 3-input XOR gate (exclusive OR gate) based on QCA with the minimum delay, area and complexities. Then, we will use XOR gates presented in this paper, in 2-bit, 4-bit and 8-bit controllable inverter in QCA. Being potentially pipeline, the QCA technology calculates with the maximum operating speed. We can use this controllable inverter in the n-bit adder/subtractor and reversible gate.

**Keywords:** Exclusive OR(XOR) gate, Inverter, Majority gate, Quantum-dot Cellular Automata(QCA).

## 1. INTRODUCTION

Quantum-dot Cellular Automata (QCA) is a promising model emerging in nanotechnology. In QCA, binary data appear as loading quantum-dots within the cells. XOR gates are important circuits in QCA technique because they are expected to be used in adder and reversible gate at nano-scale. QCA is a known technology that can be a good replacement for CMOS-based devices in nano-scale.

After decades of its final growth the minimum feature in CMOS technology, is ultimately confronted with limitations. In QCA, binary data appear as loading quantum-dots within the cells. Numerous studies are reported in which QCA is able to produce devices with high density, low power consumption and very high switching speed.

QCA was first proposed by Lent et.al in 1993 [1], and

was developed in 1997 [2]. It is expected that QCA plays an important role in nanotechnology research. Due to significant features of QCA, high density, low power consumption, very high processing potential and being pipeline, it has become an interesting alternative for CMOS technology. Using molecular QCAs we can have a density higher than 100 devices ( $\sim 3 \times 10^{11}$  – 18nm cells) per  $\text{cm}^2$  and a performance faster than 2.5 THz. Theoretically, processing speed may reach 25 THz [1].

In this paper we concentrate on designing, implementing and analyzing a basic device in QCA and use it in one of the most fundamental circuits in QCA. Designing method in QCA is different from the CMOS so that we will use quantum cells in QCA as transistor in CMOS technology. In this paper, we will present new design of 2-input and 3-input XOR gate with minimum number of cells

and delay and complexity. This 2-input XOR gate is used in designing a controllable inverter, and finally using this 3-input XOR gate, we can design a double controllable inverter.

We follow two objectives in our designs: 1. Implementation with the minimum complexity and number of cells; 2. Simplification of connections and decreasing delays and consequently increasing processing speed. Designing a 2-bit controllable inverter is the less studied new technology. It can also be generalized to 4, 8 and higher bits. Most of previous studies have been conducted on XOR gate. Several QCA-based XOR designs have been proposed in [3, 4]. Tougaw *et al.*

[3] present the design of basics quantum-dot cellular automata (QCA) XOR gate. Mustafa *et al.* [4] present novel design of quantum-dot cellular automata (QCA) XOR gate. Each of the XOR gate [3, 4], has an inordinate latency and very complex circuit.

The noise coupling problem is solved by arranging the QCA cells and assigning the clocking zones in such a way, that unwanted signal coupling is diminished, resulting in implementation requiring only one layer of QCA cells (including all the logic and interconnection).

Robust operation is achieved with very high clock frequencies, verified by the time-dependent

simulation of the QCADesigner bistable engine. Furthermore, we have used 2DDwave clocking method [5] that led to decreased delay and increased operating speed in circuit. This controllable inverter circuit is applicable in the n-bit adder/subtractor and reversible gate [6-7].

This paper is organized as follows: section 2 reviews the QCA. In section 3, the design and architecture of 2-input and 3-input XOR gate in QCA are shown. 2, 4 and 8-bit controllable inverter implementation in QCA are also presented in section 4. In section 5, simulation results are shown. Finally, we conclude the paper in the last section.

## 2. QCA REVIEW

### 2.1. Background

The main units of QCA are QCA cells located on the vertices of a square by four quantum-dots. There are two electrons in each cell which can be located, according to Coulomb electrostatic interaction, in diagonal position. The electrons are controlled by potential barriers and can move by tunneling and controlling the potential barriers and produce our binary values.

It is assumed that tunneling to outside the cells is impossible due to large potential barriers. Binary

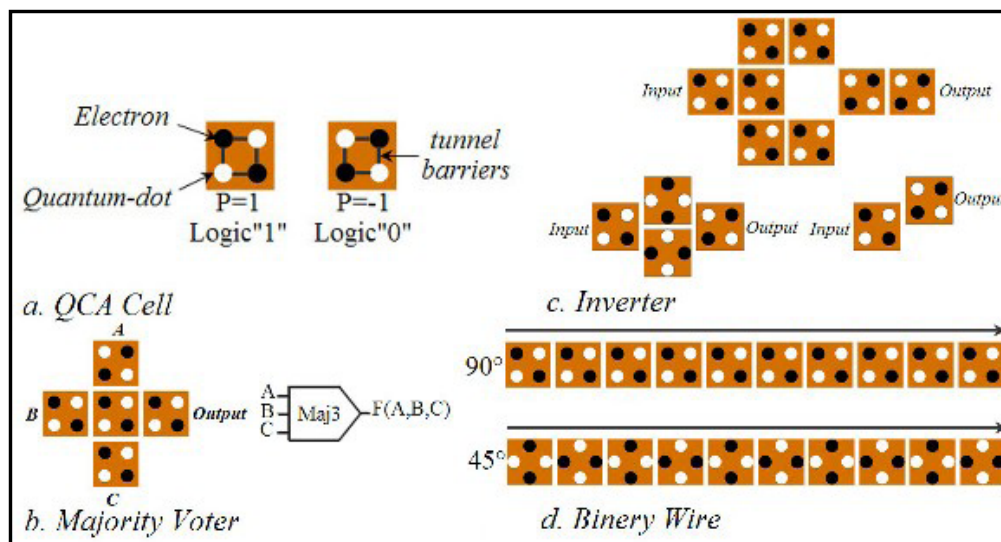

**Figure 1:** Basic QCA logic devices (a) QCA cell, (b) Majority voter (MV), (c) Inverter, (d) Binary wire

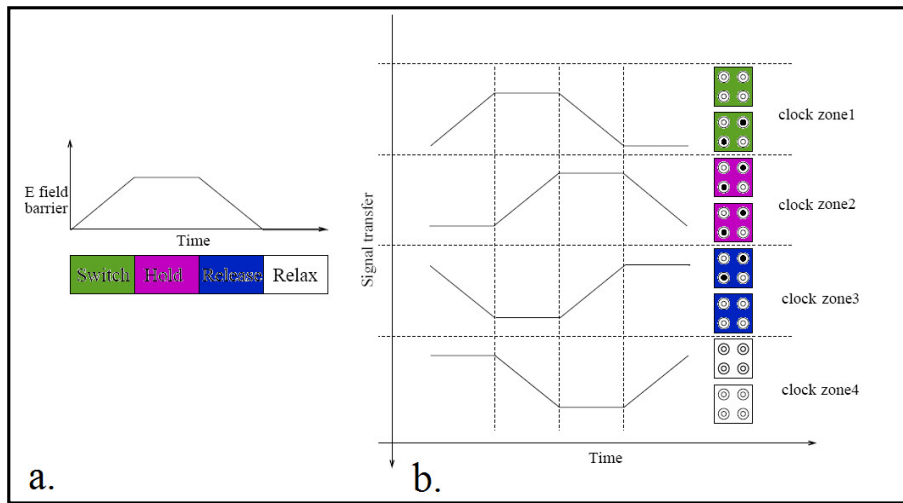

**Figure 2:** Four phases of the QCA clock, (b) Clock zones signal.

data can be encoded in two possible polarizations (1,-1) so that 0, 1 will respectively produce our binaries in QCA, as observed in Figure 1(a). If two cells are located beside each other, the Coulomb interaction between the electrons causes the cells to have equal polarization and an equal amount of their left side cell. The most fundamental logical gate in QCA is majority gate. A logical equation for a majority gate is:

$$F(A,B,C)=AB+AC+BC$$

It is implemented by five QCA cells as shown in Figure 1(b). If we keep the polarization of one of the majority gate inputs constant on 1 or 0, we will obtain OR and AND gates, respectively. Another high-consumption and important gate in QCA is NOT or inverter gate. Two common and new examples of such gates are presented in Figure 1(c). Having AND, OR and NOT gates, we are able to design and implement the most complex logical circuits. In Figure 1(d) a number of QCA cells are located next to each other creating a wire in QCA.

This wire is of two types: 45 and 90 degrees, which are applicable in cross over [8-10].

## 2.2. QCA clocking

All proposed circuits in QCA not only need a clock to synchronize and control information flow but also this clock provides the necessary power to run the circuit. QCA calculations by tunneling are performed by four phases of clock signal, as you observe in Figure 2. Clocking in QCA includes four phases: hold, release, relax and switch. Each phase is 90 degrees behind the other.

During switch phase, the potential barriers among quantum dots raise gradually and QCA cell will be located in one of the existing polarization states with regard to the adjacent cell. During hold phase, the barriers between quantum-dots remain at their higher levels preventing tunneling of electrons, and polarization of QCA cells will remain the same.

During release and relax phases, the barriers between quantum-dots reduce to its minimum value

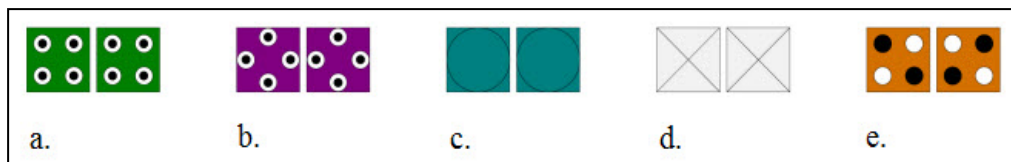

**Figure 3:** QCADesigner cells: (a) normal cell, (b) rotate cell, (c) vertical cell, (d) cross over cell, and (e) fix polarization cell.

in relax phase and the electrons will be able to move within the cell. The clock signal can be produced by an inducer electric field and is embedded under the lower surface of QCA by CMOS wires [5, 11-12]. QCADesigner is a tool generally used for simulating the QCA circuits. A QCA model might be of single layer or multi layer. In a single layer design, only normal cells, rotate cells and fix polarization cells are used. These findings are depicted in Figure 3(a), 3(b) and 3(e). When a QCA signal moves from one layer to another, it goes via vertical cells (Figure 3(c)). Then, in the upper layer, it propagates through cross over cells (Figure 3(d)). Finally, it can go down to the main layer via vertical cells [13].

### 3. ARCHITECTURE OF PROPOSED 2-INPUT AND 3-INPUT XOR GATE IN QCA

In this article, we have designed a hierarchical circuit. First, we designed a 2-input XOR and then the 3-input XOR. With a series connection of this XOR we produced the inverter of the n-bit digits with control lines.

#### 3.1. 2-input XOR gate in QCA

The 2-input XOR gate in the logic mode has the

following function: if two input lines have the same amounts, the output value becomes “0” and if two input lines have different values, the output equals to “1”. Therefore, this gate has diverse and extensive functions in different circuits. Figure 4(a) exhibits logic implementation of 2-input XOR gate and Figure 4(b) exhibits the proposed 2-input XOR gate implementation in QCA technique.

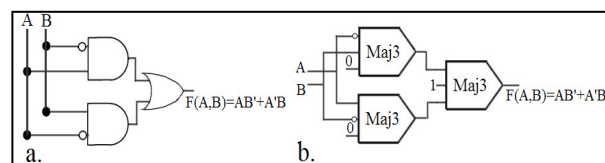
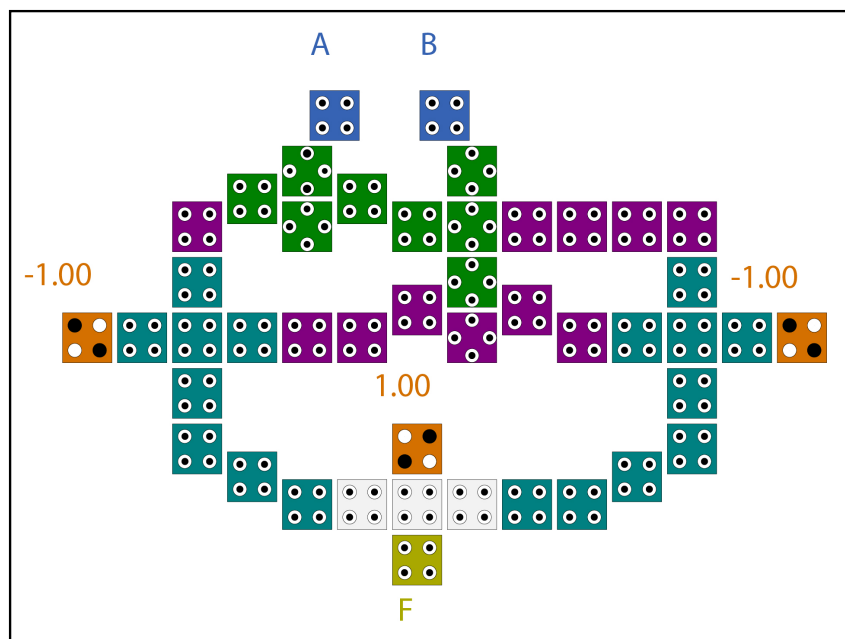

**Figure 4:** 2-input XOR gate implemented by (a) logical gate, (b) QCA with majority gate.

This gate bears the logic equation of

$$F(A,B) = A \oplus B = A'B + AB'$$

The circuit was designed and simulated for functional behavior using the QCADesigner Ver. 2.0.3. In the bistable approximation, the following parameters were used: Number of samples = 50000, Convergence tolerance = 0.001, Radius of effect = 65nm, Relative permittivity = 12.9, Clock high =



**Figure 5:** 2-input XOR gate implemented in QCA.

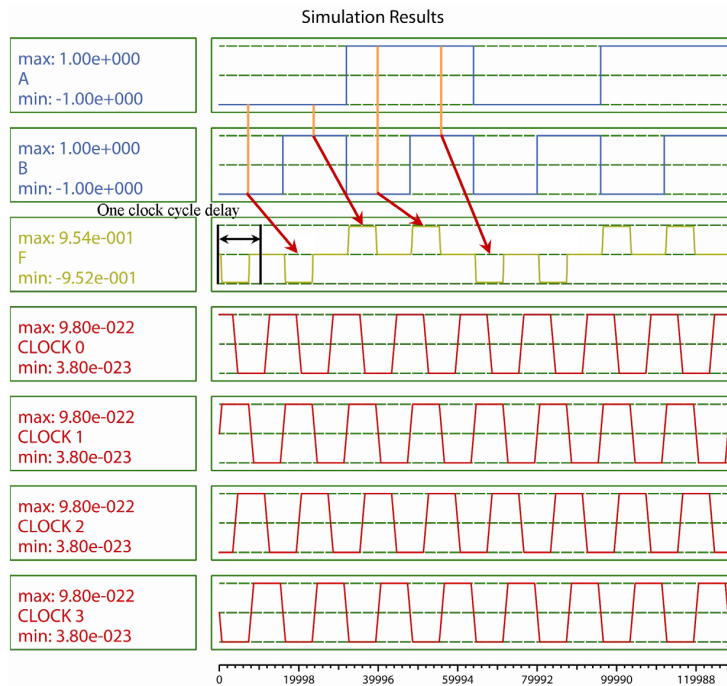

**Figure 6:** Simulation results for proposed 2-input XOR gate in QCA.

9.8e-022, Clock low = 3.8e-023, Clock shift = 0, Clock amplitude factor = 2, Layer Separation=11.5, Maximum iteration per sample = 100.

Implementation of 2-input XOR gate in QCA has been exhibited in Figure 5, which was implemented by the minimum cell number and complexity and reached the output in one clock cycle.

The proposed 2-input XOR gate consists of 45 cells covering an area of 0.05  $\mu\text{m}^2$  (278nm $\times$ 178nm). The simulation results of the 2-input XOR gate is presented in Figure 6.

### 3.2. 3-input XOR gate in QCA

The 3-input XOR gate is a combinational circuit producing the arithmetical XOR of three bits. This circuit includes three inputs and one output. Here, we will implement our 3-input XOR using two 2-input XOR. Two input variables indicated with A and B are connected to the first-stage of XOR gate. The third input C is lower value and connected to the second-stage of XOR gate. The 3-input XOR gate in the logic mode has the following function: if three input lines have same amounts, the output value

becomes “0” and if two input lines have “0” values, the output equals “1” and if two input lines have “1” values, the output equals to “0”. Therefore, this gate has diverse and extensive functions in different circuits. Figure 7(a) exhibits logic implementation of 3-input XOR gate and Figure 7(b) exhibits the proposed 3-input XOR gate implementation in QCA technique.

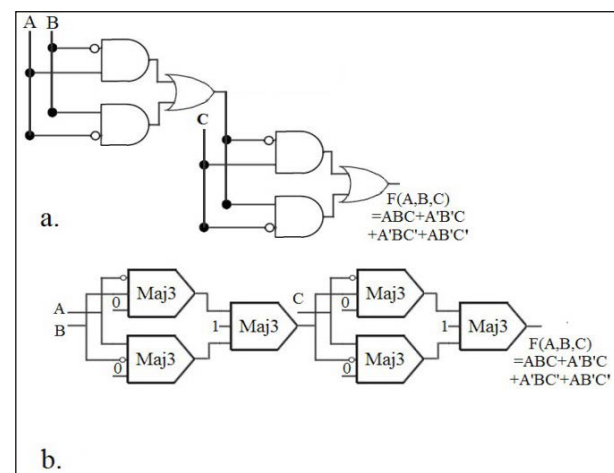

**Figure 7:** 3-input XOR gate implemented by (a) logical gate, (b) QCA with majority gate.



This gate bears the logic equation of

$$F(A,B,C) = A \oplus B \oplus C$$

$$= ABC + A'B'C + A'BC' + AB'C'$$

And has a truth table as per Table I.

**Table I:** Truth table of the 3-input exclusive OR(XOR) gate

C	A	B	F(A,B,C)
0	0	0	0
0	0	1	1
0	1	0	1
0	1	1	0
1	0	0	1
1	0	1	0
1	1	0	0
1	1	1	1

Implementation of 3-input XOR gate in QCA is exhibited in Figure 8, which was implemented by the minimum cell number and complexity and reached the output in two clock cycles.

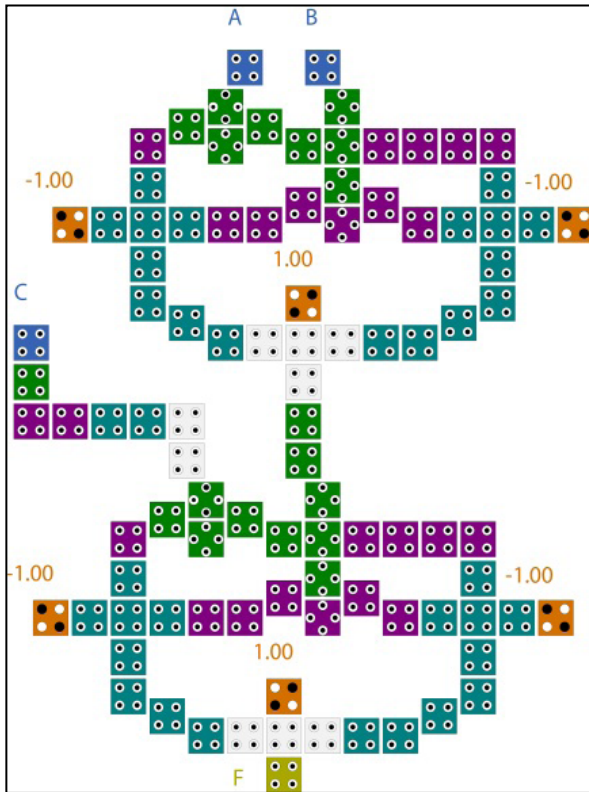

**Figure8:** 3-input XOR gate implemented in QCA.

The proposed 3-input XOR gate consists of 98 cells covering an area of 0.13  $\mu\text{m}^2$ . The simulation results of the 3-input XOR gate is presented in Figure 9.

#### 4- CONTROLLABLE INVERTER IMPLEMENTATION IN QCA

The controllable inverter is a combinational circuit which performs arithmetic operations i.e. inverted the binary digits. In this paper, we have designed a hierarchical circuit. First, we designed a controllable inverter based on 2-input XOR gate. With a series connection of two or four 2-input XOR gate, we obtained the inverted of 2 and 4-bit. Then, the controllable inverter circuit was made by 3-input XOR gate. We have designed 2 and 4-bit double controllable inverter with 3-input XOR gate in QCA.

##### 4.1. Controllable inverter implementation with 2-input XOR gate in QCA

In order to implement controllable inverter circuit, we used the proposed 2-input XOR gates and 2-input XOR gate features in inverter operations. In the first state, two 2-input XOR gates were located next to each other. Then we connected one of the input gate pins to two input data, and other pins were connected to each other and used as controller input. In this circuit, if the control input was loaded on zero, the output remained the same value, and if the control input was loaded on one, the output was inverted. The layout of 2-bit controllable inverter in QCA is presented in Figure 10.

In the second state, two 2-input XOR gates were located next to each other. Then we connected one of the input gate pins to four input data, and other pins were connected to each other and used as control input. The layout of 4-bit controllable inverter in QCA is presented in Figure 11.

##### 4.2. Double controllable inverter implementation with 2-input XOR gate in QCA

In order to implement double controllable inverter circuit, we used the proposed 3-input XOR gates and 3-input XOR gate features in inverter operations. In the first state, two 3-input XOR gates were located

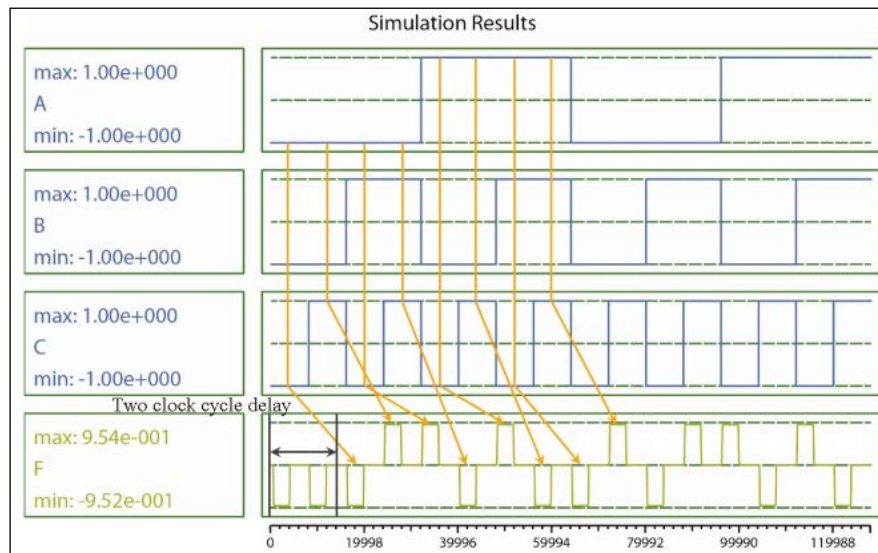

**Figure 9:** Simulation results for proposed 3-input XOR gate in QCA.

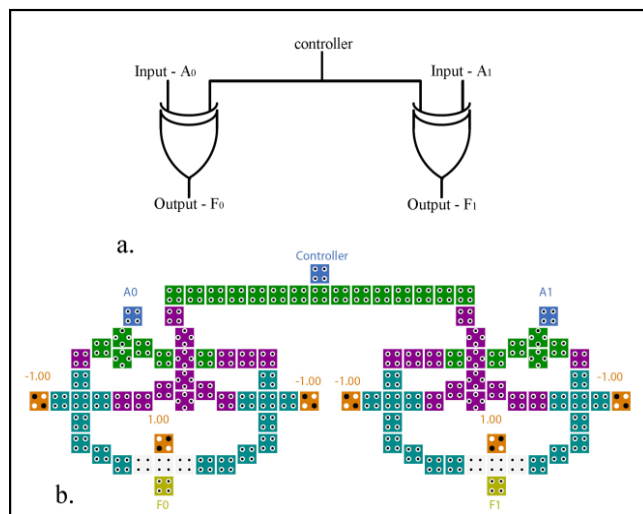

**Figure 10:** 2-bit controllable Inverter implemented in QCA.

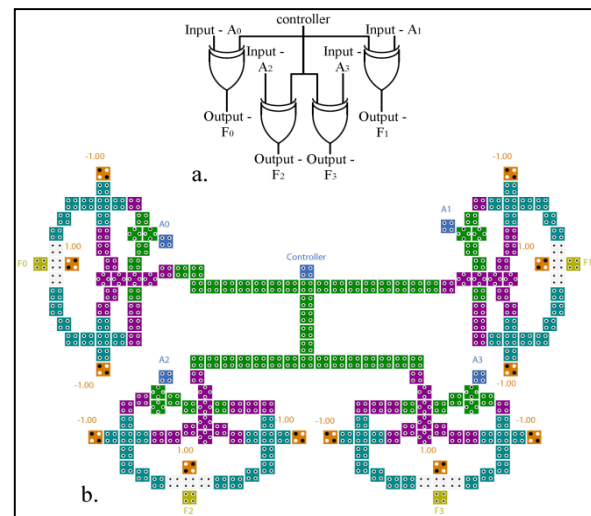

**Figure 11:** 4-bit controllable Inverter implemented in QCA.

next to each other. Then we connected one of the input gate pins to two input data, and twin other pins were connected to each other and used as controller input. In this circuit, if the two control input was loaded on “00 & 11”, the output remained the same value, and if the control input was loaded on “01 & 10”, the output was inverted. The layout of 2-bit double controllable inverter in QCA is presented in Figure 12. Generalizing this 2-bit double controllable inverter provided only requires a driver circuit. For example, if we want a 4-bit double controllable inverter

implementations, we need four, 3-input XOR gates. This 4-bit double controllable inverter will attain the output in the three clock cycles.

## 5. SIMULATION RESULT

In our design we used QCADesigner Ver. 2.0.3 in the bistable approximation. Table II, presents a brief description for each parameter used for a simulation engine [14].

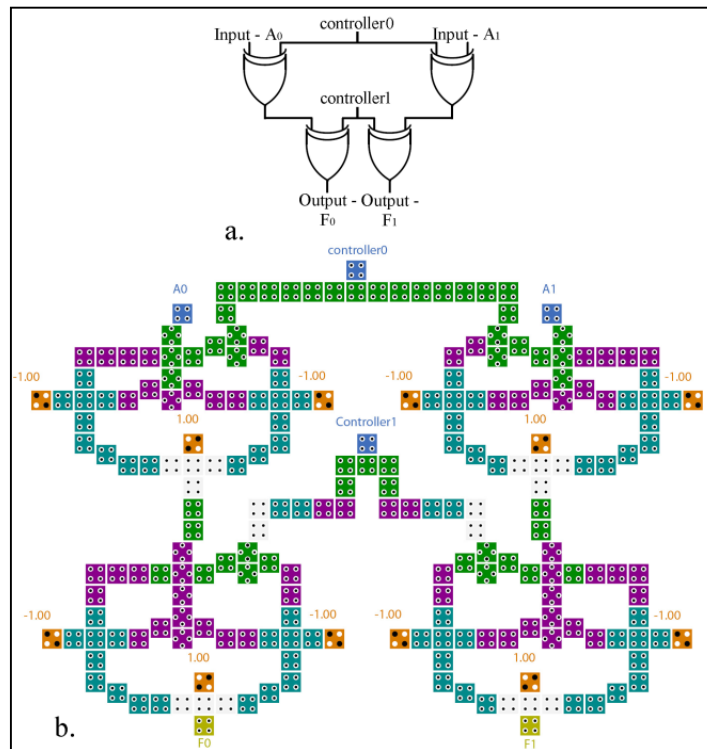

Figure 12: 2-bit double controllable Inverter implemented in QCA.

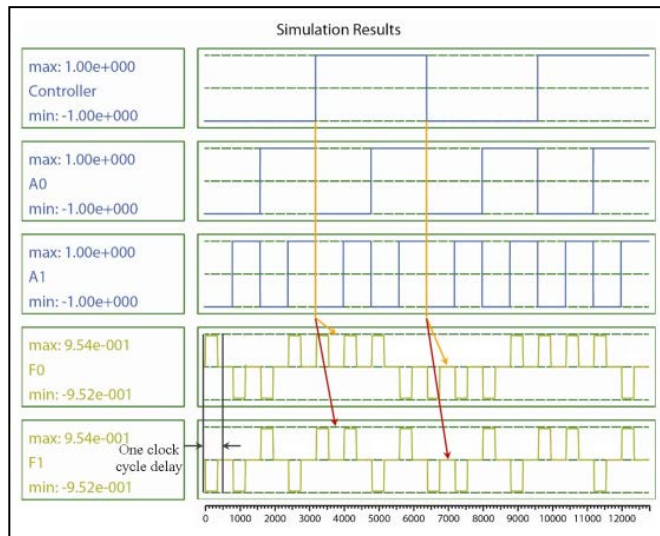

Figure 13: Simulation results for proposed 2-bit controllable inverter in QCA.

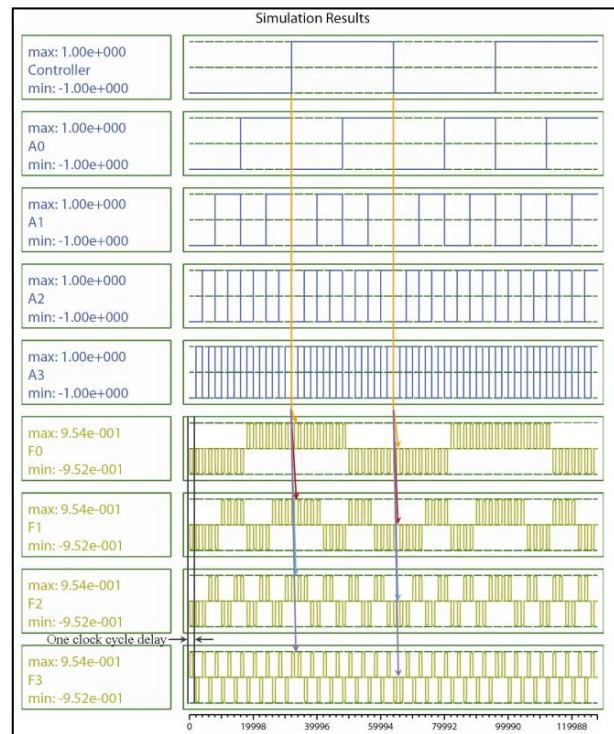

Figure 14: Simulation results for proposed 4-bit controllable inverter in QCA.



**Table II:** Parameters model in QCA Designer simulator

Parameter	Value
Cell width	18nm
Cell height	18nm
Dot diameter	5nm
Number of samples	50000 – 1000000
Convergence tolerance	0.001
Radius of effect	65nm
Relative permittivity	12.9
Clock high	9.8e-22J
Clock low	3.8e-23J
Clock amplitude factor	2
Layer Separation	11.5nm
Maximum iteration per sample	100

In Table III, we made a comparison of area ( $\mu\text{m}^2$ ), complexity (number of cells), delay ( $10^{-12}$ s in 1THz) and power consumption in proposed new circuits in QCA.

Figure 13 illustrates simulation of 2-bit controllable Inverter which came to the output with a four clock phase delay. However, Figure 14 shows the simulated 4-bit controllable Inverter which reached the output by four clock phase delay.

Figure 15 shows simulation result of proposed 2-bit double controllable Inverter. In this simulation, the results reached output correctly, after two clock cycle delay.

**Table III:** Simulation result of proposed new circuits in QCA

	Area ( $\mu\text{m}^2$ )	Complexity (# Cell)	Delay ( $10^{-12}$ s in 1 THz)
proposed 2-input XOR gate	0.05	45	1
2-input XOR gate in [3]	0.06	64	unknown
2-input XOR gate in [4]	0.07	44	1
3-input XOR gate	0.13	98	2
2-bit controllable Inverter	0.16	106	1
4-bit controllable Inverter	0.37	218	1
2-bit double controllable Inverter	0.31	219	2

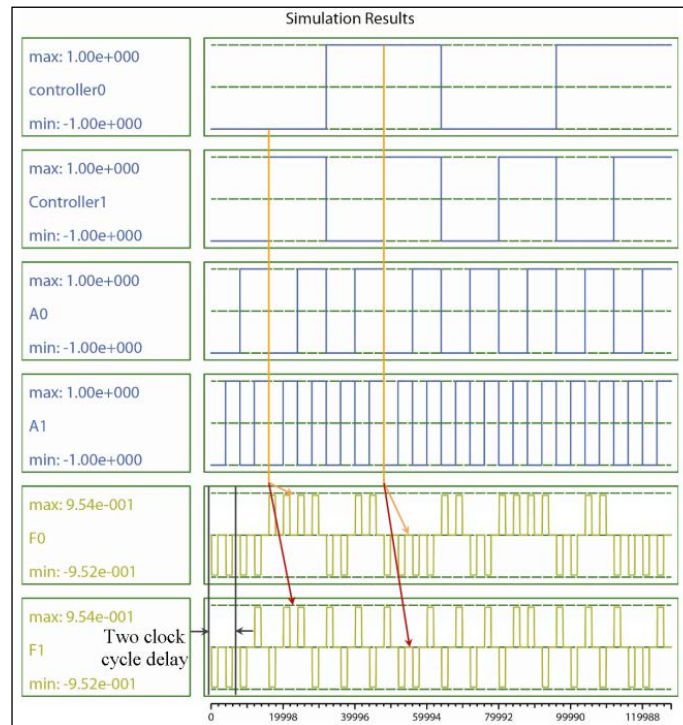

**Figure 15:** Simulation results for proposed 2-bit double controllable inverter in QCA.

## 6. CONCLUSION

We have proposed a new extendable design of 2-input and 3-input XOR gate in QCA technique. Using proposed XOR gates in this paper, the 2-bit and 4-bit controllable Inverter and 2-bit double controllable Inverter gates have been designed and implemented with minimum delay, complexity and area in QCA. This controllable Inverter may be used for reversible gate or adder/subtractor for implementations with inverted circuit, which considering the pipeline is of QCA, the operational speed will be high and the consumption power and the delay will be very low.

## REFERENCES

1. C.S. Lent, P.D. Tougaw, W. Porod and G.H. Bernstein: *Nanotechnology.*, Vol. 4, No. 1, (1993), pp. 49–57.
2. I. Amlani, A. Orlov, G.H. Bernstein, C.S. Lent and G.L. Snider: *Science.*, Vol. 227, No. 5328, (1997), pp. 928–930.
3. P. Douglas Tougaw, Craig S. Lent: *journal of applied physics*, Vol.75, No.3, (1994), pp. 1818-1825.
4. M. Mustafa, M.R. Beigh: *Indian Journal of Pure & Applied Physics.*, Vol.51, No.1, (2013), pp. 60-66.
5. M. Momenzadeh, J. Huang and F. Lombardi. Chapter 3 and references therein, Boston, Artech House., (2008).
6. H. Cho, E.E. Swartzlander: *IEEE Transactions on Nanotechnology.*, Vol.6, No.3, (2007), pp. 374–384.
7. M.B. Tahoori, M. Momenzadeh, J. Huang, F. Lombardi: *Transactions on Nanotechnology.*, Vol.3, No.4, (2004), pp. 432–442.
8. I. Amlani, A.O. Orlov, G. Toth, G.H. Bernstein, C.S. Lent and G.L. Snider: *Science.*, Vol. 284, No. 5412, (1999), pp. 289–291.
9. G. Toth and C.S. Lent: *Journal of Applied Physics.*, Vol. 85, No. 5, (1999), pp. 2977–2984.
10. H. Cho and E.E. Swartzlander: *IEEE Transactions on Computers.*, Vol. 58, No. 6, (2009), pp. 721–727.
11. R. Landauer: *IBM J. Res. Develop.*, Vol. 5, No. 3, (1961), pp. 183–191.
12. C.S. Lent and P.D. Tougaw: *Proceedings of the IEEE.*, Vol. 85, No. 4, (1997), pp. 541–557.
13. J. Timler, C. S. Lent: *journal of applied physics.*, Vol.91, No.2, (2002), pp. 823-831.
14. K. Walus, T. Dysart, G. Jullien, R. Budiman: *IEEE Transactions on Nanotechnology.*, Vol.3, No.1, (2004), pp. 26-31.